



ROEDER®

**KETTENTECHNIK
ROEDER GMBH**

■ Der Katalog

Dieser Katalog zeigt Beispiele aus unserem Leistungsspektrum.

Weitere Informationen erhalten Sie auch über www.kettentechnik-roeder.de.

Gerne fertigen wir für Sie Ihren spezifischen Bedarf nach Zeichnung oder Muster an.

Bei Neukonstruktionen sind wir selbstverständlich beratend für Sie tätig.

■ Das Unternehmen

Unser Unternehmen wurde 1968 gegründet; seit diesem Zeitpunkt haben wir uns auf die Herstellung von Sonderketten aller Art spezialisiert. In unserer Firmen-Philosophie steht Qualität und Liefertreue an erster Stelle. Für einen optimalen Kundennutzen haben wir eine hohe Beratungskompetenz aufgebaut. Durch unsere langjährige Erfahrung können wir dem Kunden optimale Lösungen präsentieren, die zudem mit optimalem Preis/Leistungsverhältnis erarbeitet werden. Außerdem garantiert unsere Erfahrung eine reibungslose Abwicklung.

■ Die Produkte

Unser Produktspektrum umfasst alle Arten von Rollenketten und Buchsenketten. Die Ketten der DIN Normen 8187 und 8188, sowie alle auf dem Markt erhältlichen Ketten, dienen uns als Grundketten. Diese werden von uns mit den vom Kunden gewünschten Anbauteilen versehen. Weiterhin fertigen wir auch Ketten mit Sonderteilungen und Sondermaterialien. Unsere Ketten finden zumeist in der Verpackungs- und Lebensmittelindustrie Verwendung. Unsere Fertigung ist auf kleinste bis mittlere Auftragsmengen eingerichtet.

■ The Catalogue

This catalogue shows samples of our scope of supply.

You receive further information through www.specialchain.com.

It would be our pleasure to manufacture chains for your specific demand according to drawing or sample.

Needless to mention that we will advise you in case of new applications

■ The Company

Our company was founded in 1968. Since then we have specialized in the production of custom made chains of all kind. Highest priority in our company philosophy is Quality and reliability in delivery.

We have achieved great competence in advise in order to gain maximum cost-/benefit ratio.

■ The Products

The scope of our supply includes all kind of roller chains and bush chains. Chains according DIN 8187 and 8188 serve as base for our custom-made design, same as all other standard chains available on the market. We also produce chains with special pitches and special materials. One of our Key-Market is the packing - and food -industry. Our production is focussing on small and medium sized orders.

■ Einsatzgebiete unserer Produkte

■ The Key Applications

■ Lebensmittel

z.B. Süßwarenverpackung



■ Food industry

e.g. packaging of sweets

■ Holzindustrie

z.B. Holztransport mit Zackenlaschenkette



■ Wood industry

e.g. slot-transport with toothed chain

■ Verpackungsmaschinen

z.B. Kippschalenketten



■ Packing machines

e.g. rocker arm chain

■ Automobilindustrie

z.B. Transportketten



■ Car industry

e.g. transport - chain

■ Schüttgüter

z.B. Kratzerketten



■ Bulk goods

e.g. scraper chain

■ Heben

z.B. Flyerketten



■ Hoisting

e.g. leafchains

■ Zuführen

z.B. Prismenlaschenketten



■ Adding

e.g. chain with prisma -links

■ Handling

z.B. Greifketten
und viele weitere.



■ Handling

e.g. grabchains
And many more.

1



3



2



4



5



6



8



9



11



7



10

12



14



15



13



16



17



18



19



20



21



22



23



24



25



26



27



28



29



31



30



33



35



32



34



36



37



41



42



45



50



51



56



57



38



40



43



39



44



46



47



49



48



52



53



55



54



58



59



60



61



62



63



64

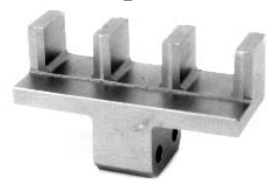

65



66



67



68



69



70

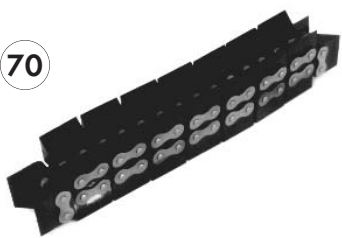

71

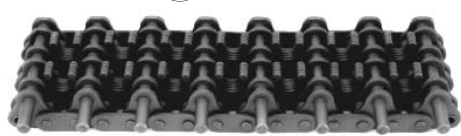

72



73



74



75



76



77



78



79



80



81



82



83



85



86



84



88



87



89



90

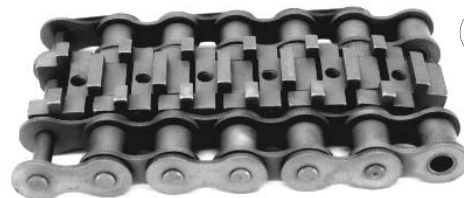

93



91



92



94

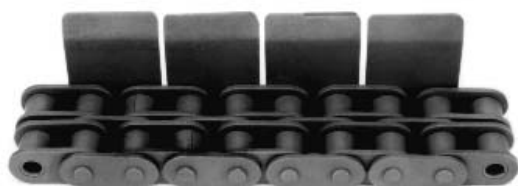

95



96



97



98



99



100



101



102



103



104



107



108



109



110



111



112



113



114



115



117



118



116



120



121



122



123



124



125



127



128



129



130



131



132



133



134



135



141



143



144



145



146



147



148



149



150



151



152



153

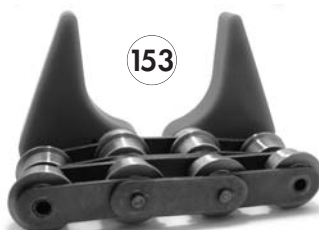

154



155



156



157



158



159



160



161



162



163



164



165



166



167



168



169



170



171



172



173



174



175



176



177



178



179



■ Anfrage Skizzen

Auf unserer Internetpräsenz haben Sie die Möglichkeit umfangreiche Zeichnungen und Skizzen herunterzuladen. Diese können dann mit Maßen versehen werden und als Anfrage-Skizzen verwendet werden.

Bitte beachten Sie: www.kettentechnik-roeder.de

Aus Platzgründen wird hier im Katalog nur ein kleiner Auszug gezeigt.

■ Sketches of enquiries

You have the possibility to download many of our custom-made chain drawings. Simply add the required dimensions onto the blanko and use the form for a detailed enquiry.

In case of doubt ask us. www.specialchain.com

Due to lack of space we are only showing a small excerpt of special chains.

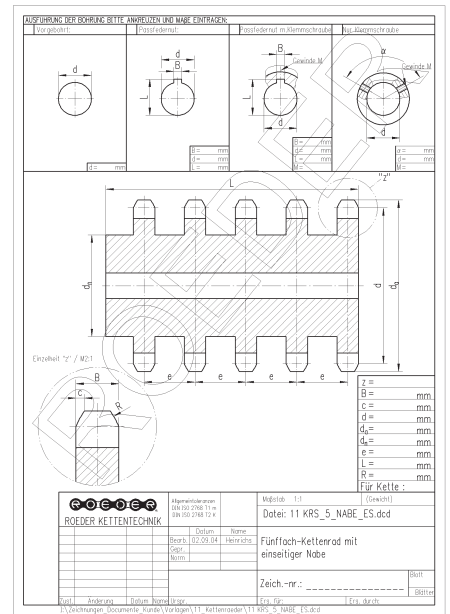
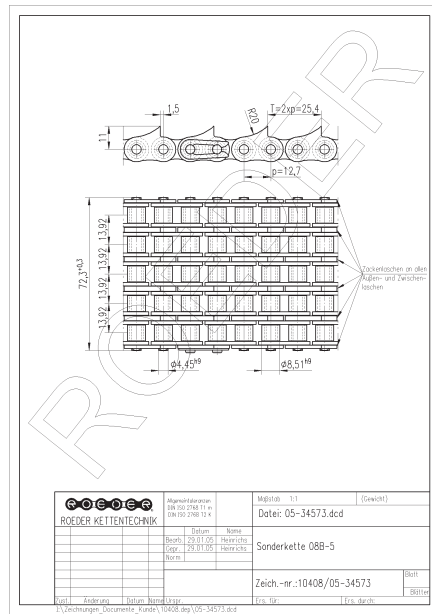
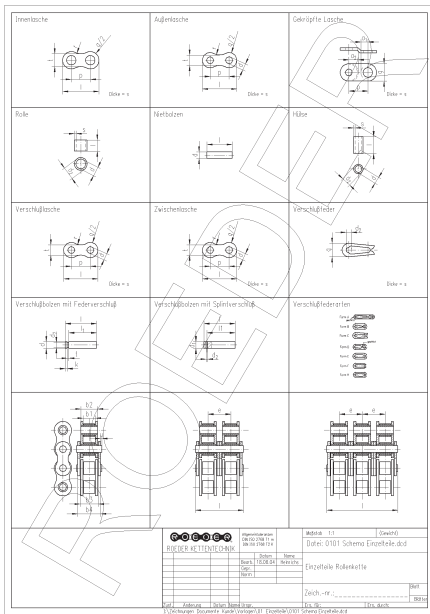

022-XXX (M1)

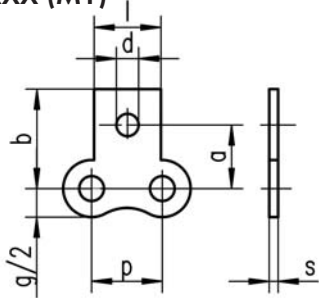

023-XXX

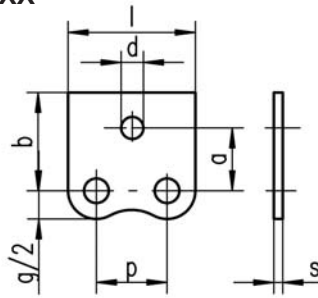

024-XXX (M2)

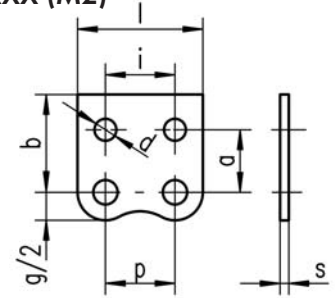

025-XXX (K1)

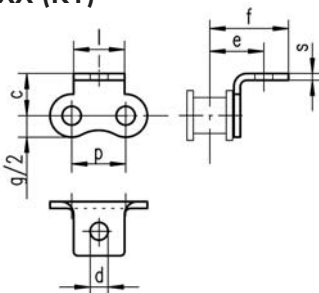

026-XXX

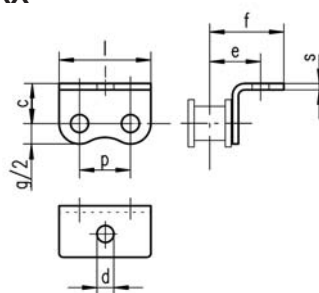

027-XXX (K2)

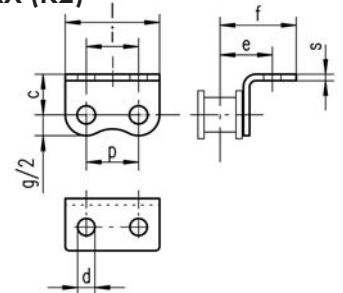

XXX Maße sowie Bestellnummer siehe www.kettentechnik-roeder.de
XXX Dimension and Ordernumber on www.kettentechnik-roeder.de

Langgliedrige Rollenketten

Double Pitch Roller Chain

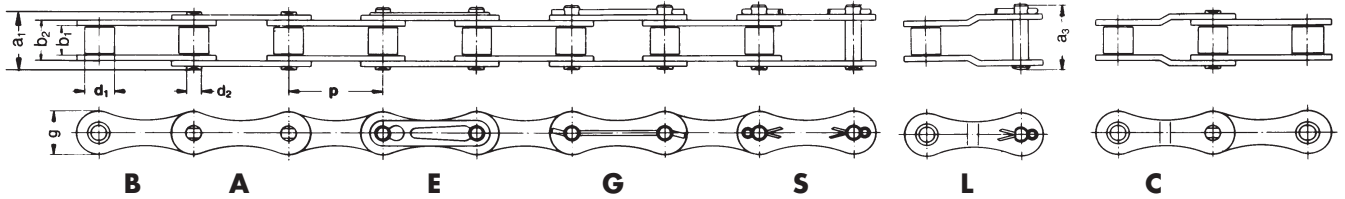

Langgliedrige Rollenketten, amerikanische Norm, DIN 8181/ISO1275

Double Pitch Roller Chains american series DIN 8181/ISO1275

DIN / ISO Ketten-Nr. Chain No	p	b ₁ min.	d ₁ max.	d ₂ max.	b ₂ max.	g max.	a ₁ max.	a ₃ max.	A max.	Bruchkraft Breaking load N min.	Einzelteile Component Parts S C E L G
208A	25,4	7,85	7,95	3,98	11,18	12,0	17,8	21,7	0,44	13 800	■ ■ ■ ■
210A	31,75	9,4	10,16	5,09	13,84	15,0	21,8	25,9	0,7	21 800	■ ■ ■ ■
212A	38,1	12,57	11,91	5,96	17,75	18,0	26,9	31,5	1,05	31 100	■ ■ ■ ■
216A	50,8	15,75	15,88	7,94	22,61	24,1	33,5	38,9	1,78	55 600	■ ■ ■

Langgliedrige Rollenketten, europäische Norm, DIN 8181/ISO1275

Double Pitch Roller Chains european series DIN 8181/ISO1275

DIN / ISO Ketten-Nr. Chain No	p	b ₁ min.	d ₁ max.	d ₂ max.	b ₂ max.	g max.	a ₁ max.	a ₃ max.	A max.	Bruchkraft Breaking load N min.	Einzelteile Component Parts S C E L G
208 B	25,4	7,75	8,51	4,45	11,3	11,8	17,0	20,9	0,5	18 000	■ ■ ■ ■
210 B	31,75	9,65	10,16	5,08	13,28	14,7	19,6	23,7	0,67	22 400	■ ■ ■ ■
212 B	38,1	11,68	12,07	5,72	15,62	16,1	22,7	27,3	0,89	29 000	■ ■ ■ ■
216 B	50,8	17,02	15,88	8,28	25,4	21,08	36,1	41,5	2,1	60 000	■ ■ ■

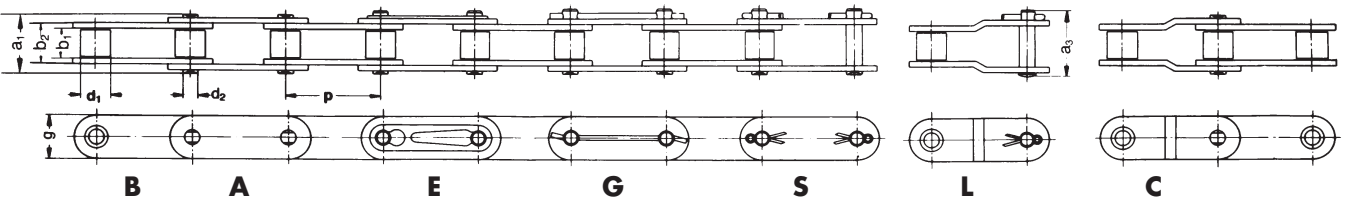

Langgliedrige Rollenketten mit geraden Laschen, amerikanische Norm, DIN 8181/ISO1275

Double Pitch Roller Chains with straight sideplates american series DIN 8181/ISO1275

DIN / ISO Ketten-Nr. Chain No	p	b ₁ min.	d ₁ max.	d ₂ max.	b ₂ max.	g max.	a ₁ max.	a ₃ max.	A max.	Bruchkraft Breaking load N min.	Einzelteile Component Parts S C E L G
C2040	25,4	7,85	7,95	3,98	11,18	12,0	17,8	21,7	0,44	13 800	■ ■ ■ ■
C2050	31,75	9,4	10,16	5,09	13,84	15,0	21,8	25,9	0,7	21 800	■ ■ ■ ■
C2060H	38,1	12,57	10,91	5,96	19,43	18,0	29,9	34,4	1,15	31 100	■ ■ ■ ■
C2080H	50,8	15,75	15,88	7,94	24,28	24,1	36,7	42,1	1,92	55 600	■ ■

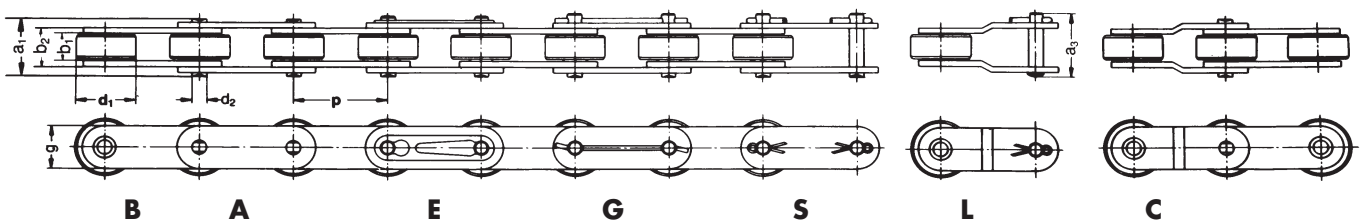

Langgliedrige Rollenketten mit geraden Laschen und Laufrollen, amerikanische Norm, DIN 8181/ISO1275

Double Pitch Roller Chains with straight sideplates and large rollers american series DIN 8181/ISO1275

DIN / ISO Ketten-Nr. Chain No	p	b ₁ min.	d ₁ max.	d ₂ max.	b ₂ max.	g max.	a ₁ max.	a ₃ max.	A max.	Bruchkraft Breaking load N min.	Einzelteile Component Parts S C E L G
C2042	25,4	7,85	15,88	3,98	11,18	12,0	17,8	21,7	0,44	13 800	■ ■ ■ ■
C2052	31,75	9,4	19,05	5,09	13,84	15,0	21,8	25,9	0,7	21 800	■ ■ ■ ■
C2062H*	38,1	12,57	22,23	5,96	19,43	18,0	29,9	34,4	1,15	31 100	■ ■ ■ ■
C2082H*	50,8	15,75	28,58	7,94	24,28	24,1	36,7	42,1	1,92	55 600	■ ■

* auch mit Delrin-Rollen lieferbar
* also with Delrin Roller available

A = Gelenkfläche
A = bearing area

Glieder A und B für alle Ketten lieferbar!
Component Part A and B for all chains available!

B = Innenglied Inner link
A = Außenglied Outer link
E = Verbindungsglied mit Feder
Connecting link with spring fastener

G = Verbindungsglied mit Draht
Connecting link with wire
S = Verbindungsglied mit Splint
Connecting link with cottered pin

L = Gekröpftes Glied mit Splint
Offset link with cottered pin
C = Gekröpftes Doppelglied
Double offset link

■ Rollenketten - Europäische Norm DIN 8187/ISO 606

■ Roller Chains - European series DIN 8187/ISO 606

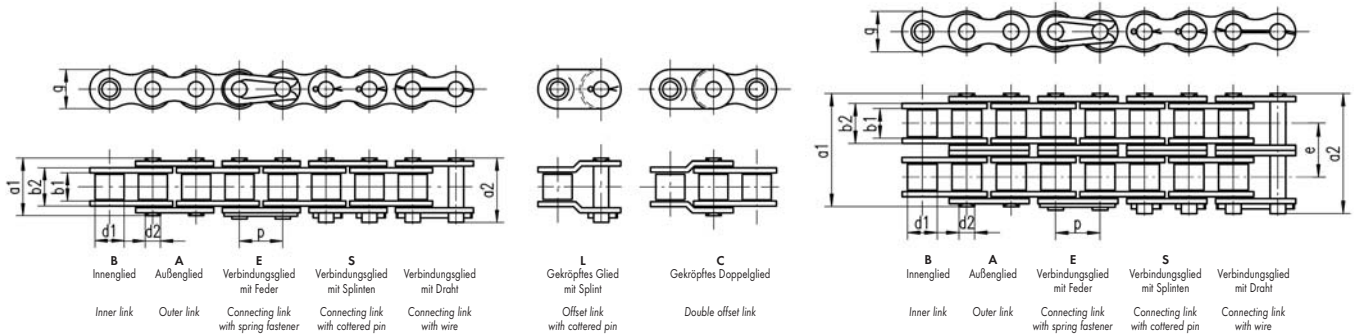

DIN / ISO Ketten-Nr. Chain No	Handelsbez. Trading name p x b ₁	p	b ₁ min.	b ₂ max.	b ₃ min.	d ₁ max.	d ₂ max.	d ₃ min.	e	g	h	k	a ₁ max.	Bruchkraft Breaking load N min.	Einzelfteile Component Parts			
															S	C	E	L
03		5	2,5	4,15	4,25	3,2	1,49	1,52		4,1	4,3	2,5	7,4	2200	■	■	■	
04	6 x 2,8	6	2,8	4,1	4,2	4	1,85	1,88		5	5,2	2,9	7,4	3000	■	■		
05 B-1	8 x 3	8	3	4,77	4,9	5	2,31	2,36		7,1	7,4	3,1	8,6	5000	■	■	■	
06 B-1	3/8" x 7/32"	9,525	5,72	8,53	8,66	6,35	3,28	3,33		8,2	8,6	3,3	13,5	9000	■	■	■	
081	1/2" x 1/8"	12,7	3,3	5,8	5,93	7,75	3,66	3,71		9,9	10,2	1,5	10,2	8200	■	■	■	1
082	1/2" x 3/32"	12,7	2,38	4,6	4,73	7,75	3,66	3,71		9,9	10,2	-	8,2	10 000	■	■	■	1
083	1/2" x 3/16"	12,7	4,88	7,9	8,03	7,75	4,09	4,14		10,3	10,6	1,5	12,9	12 000	■	■	■	1
084	1/2" x 3/16"	12,7	4,88	8,8	8,93	7,75	4,09	4,14		11,1	11,5	1,5	14,8	16 000	■	■	■	
085	1/2" x 1/4"	12,7	6,38	9,07	9,2	7,77	3,58	3,63		9,9	10,2	2	14	6 800	■	■	■	
08 B-1	1/2" x 5/16"	12,7	7,75	11,3	11,43	8,51	4,45	4,5		11,8	12,1	3,9	17	18 000	■	■	■	■
10 B-1	5/8" x 3/8"	15,88	9,65	13,28	13,41	10,16	5,08	5,13		14,7	15	4,1	19,6	22 400	■	■	■	■
12 B-1	3/4" x 7/16"	19,05	11,68	15,62	15,75	12,07	5,72	5,77		16,1	16,4	4,6	22,7	29 000	■	■	■	■
16 B-1	1" x 0,67"	25,4	17,02	25,4	25,6	15,88	8,28	8,34		21	21,4	5,4	36,1	60 000	■	■	■	■
20 B-1	1 1/4" x 3/4"	31,75	19,56	29	29,2	19,05	10,19	10,26		26,4	26,7	6,1	43,2	95 000	■	■	■	■
24 B-1	1 1/2" x 1"	38,1	25,4	37,9	38,2	25,4	14,63	14,71		33,4	33,8	6,6	53,4	160 000	■	■	■	■
28 B-1	1 3/4" x 1 7/32"	44,45	30,99	46,5	46,8	27,94	15,9	15,98		37	37,5	7,4	65,1	200 000	■	■	■	■
32 B-1	2" x 1 7/32"	50,8	30,99	45,5	45,8	29,21	17,81	17,9		42,2	42,8	7,9	67,4	250 000	■2	■	■	1
40 B-1	2 1/2" x 1 1/2"	63,5	38,1	55,7	56	39,37	22,89	23		52,9	53,5	10	82,6	355 000	■2	■	■	1
05 B-2	8 x 3	8	3	4,77	4,9	5	2,31	2,36	5,64	7,1	7,4	3,1	14,3	7 800	■	■		
06 B-2	3/8" x 7/32"	9,525	5,72	5,53	8,66	6,35	3,28	3,33	10,24	8,2	8,6	3,3	23,8	16 900	■	■	■	
08 B-2	1/2" x 5/16"	12,7	7,75	11,3	11,43	8,51	4,45	4,5	13,92	11,8	12,1	3,9	31	32 000	■	■	■	■
10 B-2	5/8" x 3/8"	15,88	9,65	13,28	13,41	10,16	5,08	5,13	16,59	14,7	15	4,1	36,2	44 500	■	■	■	■
12 B-2	3/4" x 7/16"	19,05	11,68	15,62	15,75	12,07	5,72	5,77	19,46	16,1	16,4	4,6	42,2	57 800	■	■	■	■
16 B-2	1" x 0,67"	25,4	17,02	25,4	25,6	15,88	8,28	8,34	31,88	21	21,4	5,4	68	106 000	■	■	■	■
20 B-2	1 1/4" x 3/4"	31,75	19,56	29	29,2	19,05	10,19	10,26	36,45	26,4	26,7	6,1	79	170 000	■	■	■	■
24 B-2	1 1/2" x 1"	38,1	25,4	37,9	38,2	25,4	14,63	14,71	48,36	33,4	33,8	6,6	101	280 000	■	■	■	■
28 B-2	1 3/4" x 1 7/32"	44,45	30,99	46,5	46,8	27,94	15,9	15,98	59,56	37	37,5	7,4	124	360 000	■	■	■	■
32 B-2	2" x 1 7/32"	50,8	30,99	45,5	45,8	29,21	17,81	17,9	58,55	42,2	42,8	7,9	126	450 000	■2	■	■	1
40 B-2	2 1/2" x 1 1/2"	63,5	38,1	55,7	56	39,37	22,89	23	72,29	52,9	53,5	10	154	630 000	■2	■	■	1
05 B-3	8 x 3	8	3	4,77	4,9	5	2,31	2,36	5,64	7,1	7,4	3,1	19,9	11 100	■	■		
06 B-3	3/8" x 7/32"	9,525	5,72	8,53	8,66	6,35	3,28	3,33	10,24	8,2	8,6	3,3	34	24 900	■	■	■	
08 B-3	1/2" x 5/16"	12,7	7,75	11,3	11,43	8,51	4,45	4,5	13,92	11,8	12,1	3,9	44,9	47 500	■	■	■	
10 B-3	5/8" x 3/8"	15,88	9,65	13,28	13,41	10,16	5,08	5,13	16,59	14,7	15	4,1	52,8	66 700	■	■	■	
12 B-3	3/4" x 7/16"	19,05	11,68	15,62	15,75	12,07	5,72	5,77	19,46	16,1	16,4	4,6	61,7	86 700	■	■	■	
16 B-3	1" x 0,67"	25,4	17,02	25,4	25,6	15,88	8,28	8,34	31,88	21	21,4	5,4	99,9	160 000	■	■	■	■
20 B-3	1 1/4" x 3/4"	31,75	19,56	29	29,2	19,05	10,19	10,26	36,45	26,4	26,7	6,1	116	250 000	■	■	■	■
24 B-3	1 1/2" x 1"	38,1	25,4	37,9	38,2	25,4	14,63	14,71	48,36	33,4	33,8	6,6	150	425 000	■	■	■	■
28 B-3	1 3/4" x 1 7/32"	44,45	30,99	46,5	46,8	27,94	15,9	15,98	59,56	37	37,5	7,4	184	530 000	■	■	■	■
32 B-3	2" x 1 7/32"	50,8	30,99	45,5	45,8	29,21	17,81	17,9	58,55	42,2	42,8	7,9	184	670 000	■2	■	■	1
40 B-3	2 1/2" x 1 1/2"	63,5	38,1	55,7	56	39,37	22,89	23	72,29	52,9	53,5	10	227	950 000	■2	■	■	1

Ergänzungen zum Tabellenkopf Addition to the head of the chart

b₃ Lichte Weite Außenglied inner width outer link
h erforderliches äußeres Spiel min. outside tolerance
d₃ Innendurchmesser Hülse inner diameter bush

a₂ = a₁ + k

- nur mit geraden Laschen lieferbar
only with straight plates available
- ▲ auch mit geraden Laschen lieferbar
also with straight plates available

- 1) mit Schraubverschluß
connecting link with screw
- 2) mit Klemmring
with circlip

Glieder A und B für alle Ketten lieferbar!
Component Part A and B for all chains available!

Rollenkettens - Amerikanische Norm DIN 8188/ISO 606

Roller Chains - American series DIN 8188/ISO 606

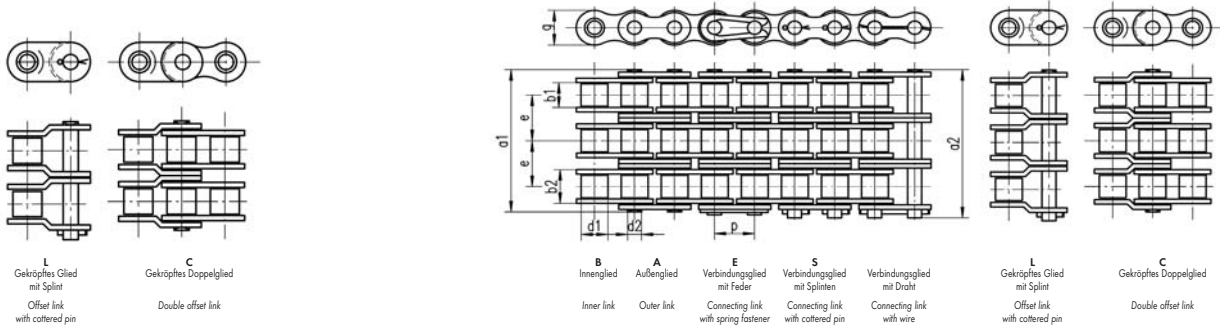

DIN / ISO Ketten-Nr. Chain No	Handelsbez. Trading name $\rho \times b_1$	ρ	b_1 min.	b_2 max.	b_3 min.	d_1 max.	d_2 max.	d_3 min.	e	g max.	h min.	k max.	a_1 max.	Bruchkraft Breaking load N min.	Einzelteile Component Parts S C E L				
															S	C	E	L	
25	04C-1	1/4" x 1/8"	6,35	3,1	4,8	4,85	3,3	2,31	2,34		6,02	6,27	2,5	9,1	3500	■	■		
35	06C-1	3/8" x 3/16"	9,525	4,68	7,47	7,52	5,08	3,58	3,63		9,05	9,3	3,3	13,2	7900	■	■		
40	08A-1	1/2" x 5/16"	12,7	7,85	11,15	11,28	7,95	3,96	4,01		12	12,4	3,9	17,8	14 100	■	■	■	
50	10A-1	5/8" x 3/8"	15,875	9,4	13,8	13,93	10,16	5,08	5,13		15	15,4	4,1	21,8	22 200	■	■	■	
60	12A-1	3/4" x 1/2"	19,05	12,57	17,7	17,85	11,91	5,94	5,99		18	18,4	4,6	26,9	31 800	■	■	■	
80	16A-1	1" x 5/8"	25,4	15,75	22,5	22,7	15,88	7,92	7,98		24,1	24,4	5,4	33,5	56 700	■	■	■	■
100	20A-1	1 1/4" x 3/4"	31,75	18,9	27,4	27,6	19,05	9,53	9,59		30,1	30,5	6,1	41,1	88 500	■	■	■	
120	24A-1	1 1/2" x 1"	38,1	25,22	35,3	35,6	22,23	11,1	11,17		36,2	36,6	6,6	50,8	127 000	■	■	■	
140	28A-1	1 3/4" x 1"	44,45	25,22	37	37,3	25,4	12,7	12,77		42,2	42,7	7,4	54,9	172 400	■	■	■	
160	32A-1	2" x 1 1/4"	50,8	31,55	45	45,3	28,58	14,27	14,35		48,2	48,8	7,9	65,5	226 800	■	■	■	
200	40A-1	2 1/2" x 1 1/2"	63,5	37,85	54,7	55	39,68	19,84	19,92		60,3	61	10	80,3	353 800	■	■	■	
60H	12AH-1	3/4" x 1/2"	19,05	12,57	19,43		11,91	5,96			17,4				40 000	■		■	
80H	16AH-1	1" x 5/8"	25,4	15,75	24,28		15,88	7,94			23				70 000	■	■	■	
100H	20AH-1	1 1/4" x 3/4"	31,75	18,9	29,11		19,05	9,54			28,9				100 000	■		■	
120H	24AH-1	1 1/2" x 1"	38,1	25,22	37,18		22,23	11,1			36,2				141 000	■		■	
140H	28AH-1	1 3/4" x 1"	44,45	25,22	38,9		25,4	12,7			42,2				181 000	■		■	
160H	32AH-1	2" x 1 1/4"	50,8	31,55	46,89		28,58	14,29			48,2				239 500	■		■	
25-2	04C-2	1/4" x 1/8"	6,35	3,1	4,8	4,85	3,3	2,31	2,34	6,4	6,02	6,27	2,5	15,5	7 000	■	■		
35-2	06C-2	3/8" x 3/16"	9,525	4,68	7,47	7,52	5,08	3,58	3,63	10,13	9,05	9,3	3,3	23,4	15 800	■	■		
40-2	08A-2	1/2" x 5/16"	12,7	7,85	11,15	11,28	7,95	3,96	4,01	14,38	12	12,4	3,9	32,3	28 200	■	■	■	
50-2	10A-2	5/8" x 3/8"	15,875	9,4	13,8	13,93	10,16	5,08	5,13	18,11	15	15,4	4,1	39,9	44 400	■	■	■	
60-2	12A-2	3/4" x 1/2"	19,05	12,57	17,7	17,85	11,91	5,94	5,99	22,78	18	18,4	4,6	49,8	63 600	■	■	■	■
80-2	16A-2	1" x 5/8"	25,4	15,75	22,5	22,7	15,88	7,92	7,98	29,29	24,1	24,4	5,4	62,7	113 400	■	■	■	■
100-2	20A-2	1 1/4" x 3/4"	31,75	18,9	27,4	27,6	19,05	9,53	9,59	35,76	30,1	30,5	6,1	77	177 000	■	■	■	
120-2	24A-2	1 1/2" x 1"	38,1	25,22	35,3	35,6	22,23	11,1	11,17	45,44	36,2	36,6	6,6	96,3	254 000	■	■	■	
140-2	28A-2	1 3/4" x 1"	44,45	25,22	37	37,3	25,4	12,7	12,77	48,87	42,2	42,7	7,4	103	344 800	■	■	■	
160-2	32A-2	2" x 1 1/4"	50,8	31,55	45	45,3	28,58	14,27	14,35	58,55	48,2	48,8	7,9	124	453 600	■	■	■	
200-2	40A-2	2 1/2" x 1 1/2"	63,5	37,85	54,7	55	39,68	19,84	19,92	71,55	60,3	61	10	151	707 600	■	■	■	
25-3	04C-3	1/4" x 1/8"	6,35	3,1	4,8	4,85	3,3	2,31	2,34	6,4	6,02	6,27	2,5	21,8	10 500	■	■		
35-3	06C-3	3/8" x 3/16"	9,525	4,68	7,47	7,52	5,08	3,58	3,63	10,13	9,05	9,3	3,3	33,5	23 700	■	■		
40-3	08A-3	1/2" x 5/16"	12,7	7,85	11,15	11,28	7,95	3,96	4,01	14,38	12	12,4	3,9	46,7	42 300	■	■	■	
50-3	10A-3	5/8" x 3/8"	15,875	9,4	13,8	13,93	10,16	5,08	5,13	18,11	15	15,4	4,1	57,9	66 600	■	■	■	
60-3	12A-3	3/4" x 1/2"	19,05	12,57	17,7	17,85	11,91	5,94	5,99	22,78	18	18,4	4,6	72,6	95 400	■	■	■	■
80-3	16A-3	1" x 5/8"	25,4	15,75	22,5	22,7	15,88	7,92	7,98	29,29	24,1	24,4	5,4	91,7	170 100	■	■	■	■
100-3	20A-3	1 1/4" x 3/4"	31,75	18,9	27,4	27,6	19,05	9,53	9,59	35,76	30,1	30,5	6,1	113	265 500	■	■	■	
120-3	24A-3	1 1/2" x 1"	38,1	25,22	35,3	35,6	22,23	11,1	11,17	45,44	36,2	36,6	6,6	141	381 000	■	■	■	
140-3	28A-3	1 3/4" x 1"	44,45	25,22	37	37,3	25,4	12,7	12,77	48,87	42,2	42,7	7,4	152	517 200	■	■	■	
160-3	32A-3	2" x 1 1/4"	50,8	31,55	45	45,3	28,58	14,27	14,35	58,55	48,2	48,8	7,9	182	680 400	■	■	■	
200-3	40A-3	2 1/2" x 1 1/2"	63,5	37,85	54,7	55	39,68	19,84	19,92	71,55	60,3	61	10	223	1 061 400	■	■	■	

Ergänzungen zum Tabellenkopf Addition to the head of the chart

b_3 Lichte Weite Außenglied
erforderliches äußeres Spiel
 d_3 Innendurchmesser Hülse

inner width outer link
min. outside tolerance
inner diameter bush

● Buchsenkette ISO1395
Bush Chain ISO1395

Glieder A und B für alle Ketten lieferbar!
Component Part A and B for all chains available!
Tabelle enthält auch Werkserien!
Chart also includes workseries!

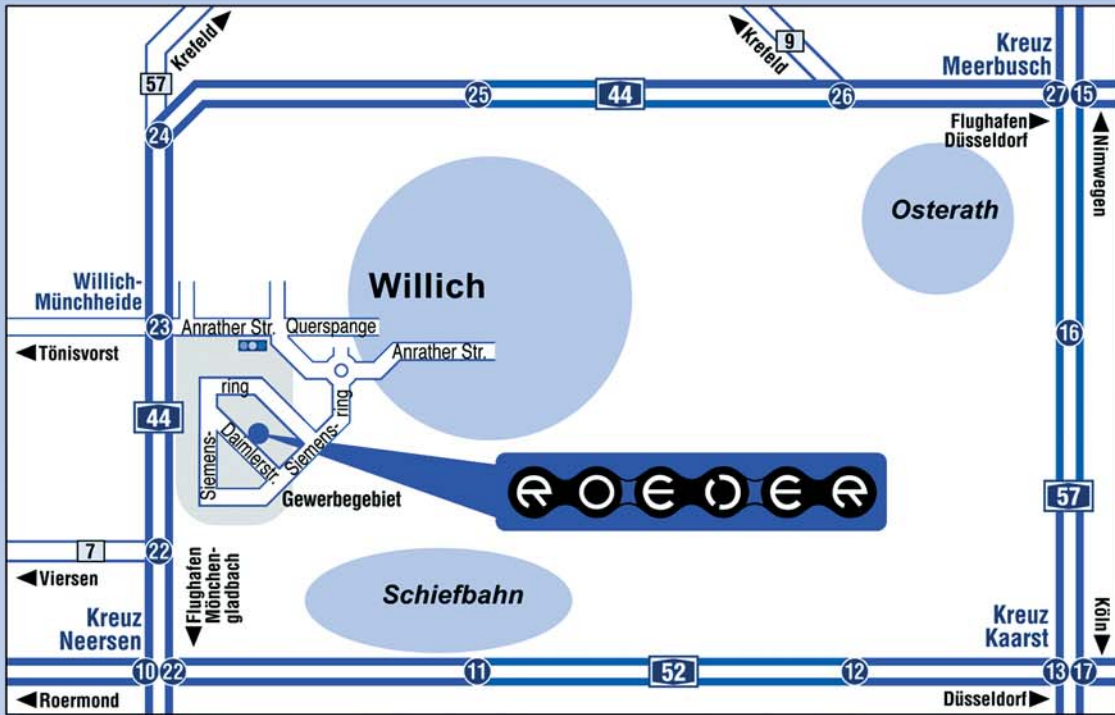

Kettentechnik Roeder GmbH

Daimlerstraße 10 · 47877 Willich
 (Gewerbegebiet Münchheide I)

Tel. 0 21 54 - 94 51 - 0
 Fax 0 21 54 - 94 51 - 11

www.Kettentechnik-Roeder.de